

variety **inox**[®]

a c e r o i n o x i d a b l e

variety **inox**[®]

a c e r o i n o x i d a b l e

variety inox®

a c e r o i n o x i d a b l e

Índice



Manillas macizas

Júpiter	11
Aristeo	11
Jano	11
Proteo	11
Titán	12
Glauco	12
Marte	12
Vesta	12
Neptuno	13
Cibeles	13
Fauno	13
Hércules	13
Silvano	14
Minerva	14
Mitra	14



Tiradores macizos

Hércules	16
Titán	16
Jano	16
Vesta	16
Cibeles	16
Glauco	17
Glauco-C	17
Júpiter 250mm	17
Júpiter 200mm	17



Manillas tubulares

Juno	19
Plutón	20
Tellus	21
Belona	22
Talía	22
Iris	22
Ceres	22
Baco	23
Cubo	23
Kit de placas	23



Tiradores tubulares

Recto con roseta	24
Set Recto (de 200 a 610mm)	25
Set recto mod. Tellus (de 200 a 500mm)	25
Set recto mod. Cubo (de 200 a 500mm)	25
Set circular (200 y 305mm)	25
Roseta para set de tiradores	25
Set curvo sin roseta (610mm)	26
Curvo con roseta (610mm)	26
Con placa rectangular	26
Con placa ovalada	26
Con placa cuadrada	26



Accesorios

Pomos fijos	28
Bocallaves	28
Condenas y desbloques	29
Señalización	30
Pasadores	30
Soportes pasamanos	30
Topes de puerta	31
Placa de limpieza	31
Pestillo y condena sobreponer	31
Retenedor	31
Tornillo embellecedor	31



Accesorios baño

Modelo Lara	32
Modelo Diana	34



Cabinas sanitarias

Soporte lateral	37
Soporte superior	37
Conector de tubo	38
Ángulo de unión	38
Condena	38
Bisagras	38
Soporte a suelo	39
Percha	39
Pomos	39
Barra tubular y perfiles	39



Barras apoyo

Barra recta 300 y 600mm	40
Barra 135°	40
Barra abatible	40



Bisagras y pernios

Pernio pala ancha	42
Pernio pala estrecha	42
Bisagra quita y pon	42
Bisagra oculta	42
Bisagra simple acción	42
Bisagra doble acción	42
Bisagra antipalanca	43

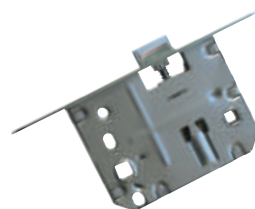

Picaportes y cerraduras

Picaporte unificado	44
Cerradura de entrada	45
Cerradura de seguridad	45



Tiradores para mueble

Tiradores embutir	46
Tirador armario y maletero	47
Asas para mueble	47
Pomos para mueble	48



Calidad Variety

Variety inox ofrece una amplia gama de herrajes fabricados en acero inoxidable.

Manillas y manillones macizos, que nos permite crear modernos y elaborados diseños para los proyectos arquitectónicos y decorativos más vanguardistas. Manillas y tiradores tubulares con diseños funcionales, limpios y minimalistas, que se complementan con gran variedad de placas y rosetas.

Además, contamos con todos los accesorios necesarios para puertas, como bocallaves, condenas, topes, pernios y bisagras, cerraduras y picaportes, sin dejar de lado la aplicación del acero inoxidable en baños con nuestros herrajes para cabinas sanitarias, barras de apoyo y accesorios para cuartos de baño.

Todo fabricado en acero inoxidable austenítico 304 de alta calidad y gran poder anticorrosivo, con acabado satinado, manteniendo altos estándares en la producción y el diseño.



Variety Inox, también online

Gracias a la web VI-VO.es todos los artículos Variety Inox, están disponibles de manera digital.

En esta plataforma web podrás descargar fichas técnicas, ampliar información de cada artículo o encontrar el punto de venta más cercano, entre otras cosas.



VI-VO.es

LA PLATAFORMA
ESPECIALISTA
EN HERRAJES

VI-VO es una web con soluciones para profesionales y amantes del herraje: carpinteros, arquitectos, decoradores de interiores... Un nuevo espacio de referencia, donde se unen las principales marcas especializadas para ofrecer un amplio catálogo de productos y todo lo necesario para una vida más funcional y cómoda.





Soluciones que mueven espacios

Baños, cocinas, dormitorios, salones, herrajes para puertas... en VI-VO. se muestran soluciones prácticas y funcionales para todas las estancias de la casa. Herrajes originales e innovadores para todo tipo de mobiliario que permiten ganar y optimizar espacio, accesorios y herrajes para puertas de paso y entrada, desde pomos, bisagras y cerrajería hasta otros más innovadores, como mirillas digitales con conexión wifi, además de una completa gama de iluminación para todos los rincones y ambientes que completa el extenso catálogo ofrecido en la web de VI-VO.



www.vi-vo.es



**ENCUENTRA TU
DISTRIBUIDOR
MÁS CERCANO**

Las manillas y accesorios presentados en este catálogo son comercializados de manera exclusiva por la red de distribuidores VI-VO, empresas con una gran experiencia en el sector para asesoramiento personal y profesional. ¡Entra en vi-vo.es y encuentra tu punto de venta más cercano!

Manillas y tiradores

La gama de manillas y tiradores Variety Inox se clasifican en dos categorías: macizas y tubulares. La gama maciza se caracteriza por estar fabricada con acero sólido, lo que le confiere mayor peso y una mayor variedad de diseños. La gama tubular es más ligera, ya que no es un material sólido y, debido a su proceso de fabricación, los diseños de los modelos son más técnicos y sencillos.

La gama maciza es perfecta para proyectos decorativos y arquitectónicos de mayor perfil creativo, mientras que la gama tubular es ideal para soluciones más técnicas, que buscan limpieza de líneas y pulcritud de formas.

Nuestras manillas y tiradores incluyen todos los elementos necesarios para su montaje.



Elementos manillas Variety Inox

- ① Manilla (2udes.)
- ② Tornillo hexagonal (2udes.)
- ③ Cuadradillo 8mm. (1ud.)
- ④ Roseta (2udes.)
- ⑤ Tornillo pasante autocortante (1ud.)
- ⑥ Llave Allen (1ud.)
- ⑦ Tornillo rosca madera (4udes.)

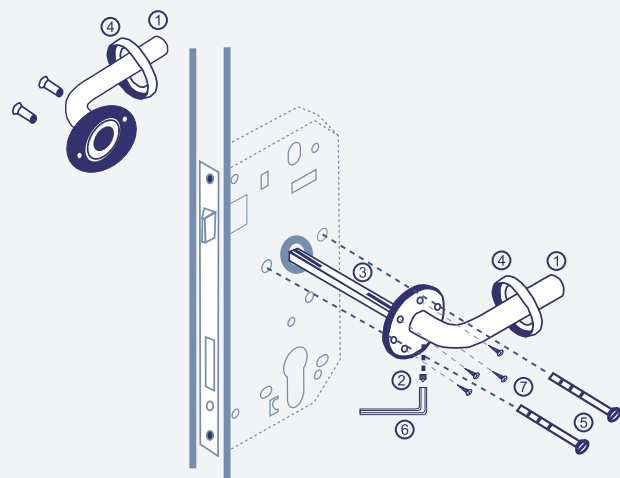

Dependiendo del modelo de manilla o tirador, vendrá montada con uno de nuestros tres tipos de roseta: estándar, roscada o cuadra.



Kit de montaje para tiradores tubulares

El kit de montaje para tiradores tubulares Variety Inox, da la opción de montaje en puertas de madera o cristal.

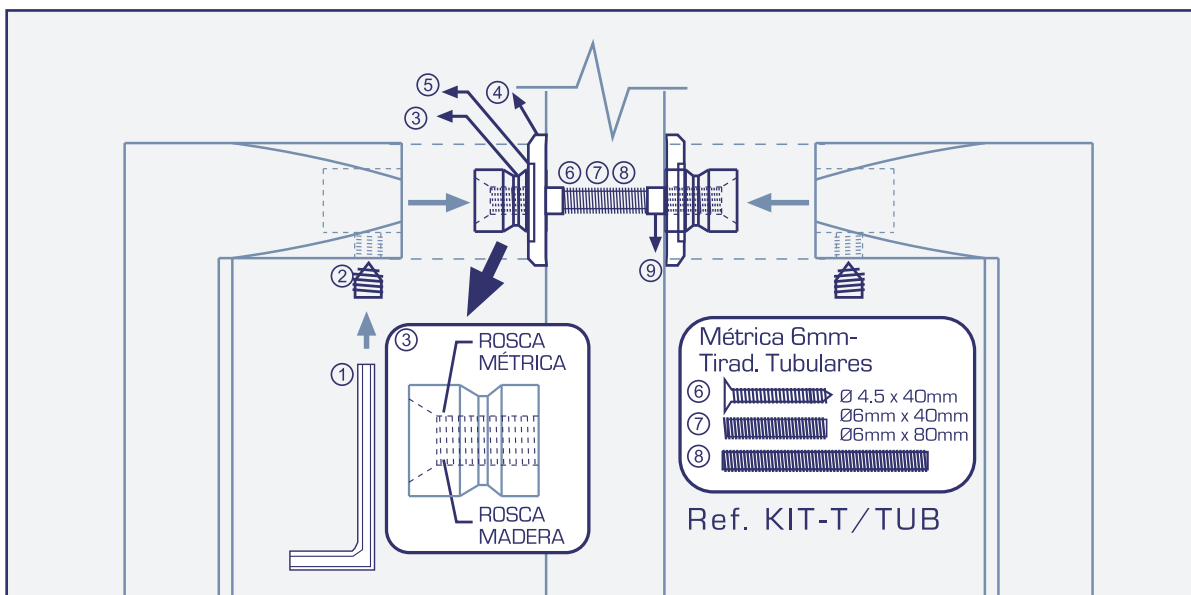

- | | | |
|-------------------------------|-----------------------------------|--------------------------------|
| ① Llave Allen (1ud.) | ④ Roseta embellecedora (4udes.) | ⑦ Esparrago 40mm M6 (2udes.) |
| ② Tornillo hexagonal (2udes.) | ⑤ Protector transparente (4udes.) | ⑧ Esparrago 80mm M6 (2udes.) |
| ③ Conector (4udes.) | ⑥ Tornillo rosca madera (4udes.) | ⑨ Protector esparrago (4udes.) |

El kit incluye miniroseta embellecedora de Ø30mm. Opción de usar el set de roseta de Ø45mm (ver página 21).



Miniroseta Ø30mm incluida en el kit



Set de roseta Ø45mm para tirador tubular. (Opcional).
Código: 26537.
Ref.: ROS-T/TUB

Manillas macizas

Júpiter	11
Aristeo	11
Jano	11
Proteo	11
Titán	12
Glauco	12
Marte	12
Vesta	12
Neptuno	13
Cibeles	13
Fauno	13
Hércules	13
Silvano	14
Minerva	14
Mitra	14

Júpiter



Referencia: Jupiter
Código: 20943
Roseta estándar

1 jgo.

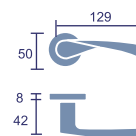

Aristeo



Referencia: Aristeo
Código: 23088
Roseta maciza

1 jgo.

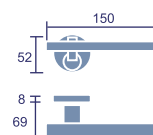

Jano



Referencia: Jano
Código: 23089
Roseta maciza

1 jgo.

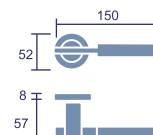

Proteo



Referencia: Proteo
Código: 23091
Roseta maciza

1 jgo.

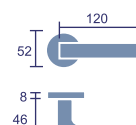

Titán



Referencia: Titan
Código: 23515
Roseta cuadrada

1 jgo.

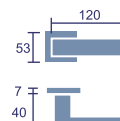

Glauco



Referencia: Glauco
Código: 23095
Roseta maciza

1 jgo.

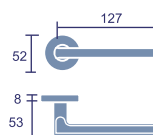

Marte



Referencia: Marte
Código: 22771
Roseta maciza

1 jgo.

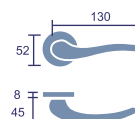

Vesta



Referencia: Vesta
Código: 22772
Roseta maciza

1 jgo.

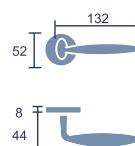

Neptuno



Referencia: Neptuno
Código: 20942
Roseta estándar

1 jgo.

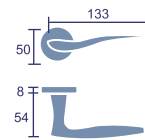

Cibeles



Referencia: Cibeles
Código: 21375
Roseta estándar

1 jgo.

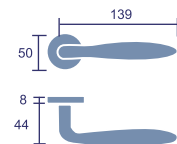

Fauno



Referencia: Fauno
Código: 22122
Roseta estándar

1 jgo.

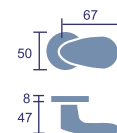

Hércules



Referencia: Hércules
Código: 20945
Roseta estándar

1 jgo.

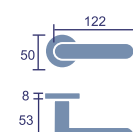

Silvano



Referencia: Silvano
Código: 20946
Roseta estándar

1 jgo.

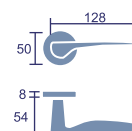

Minerva



Referencia: Minerva
Código: 21374
Roseta estándar

1 jgo.

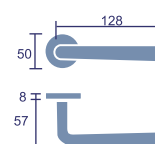

Mitra



Referencia: Mitra
Código: 26525
Roseta cuadrada

1 jgo.

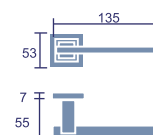

Tiradores macizos

Hércules	16
Titán	16
Jano	16
Vesta	16
Cibeles	16
Glauco	17
Glauco-C	17
Júpiter 250mm	17
Júpiter 200mm	17

Hércules

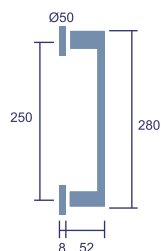

Referencia: T/Hercules
Código: 22125
Roseta estándar
1 ud.

Titán

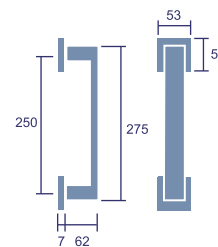

Referencia: T/Titan
Código: 25328
Roseta cuadrada
1 ud.

Jano

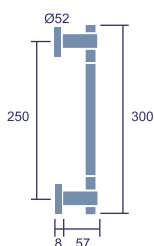

Referencia: T/Jano
Código: 23094
Roseta maciza
1 ud.

Vesta

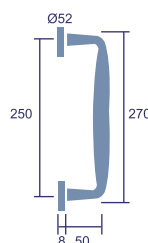

Referencia: T/Vesta
Código: 23087
Roseta maciza
1 ud.

Cibeles

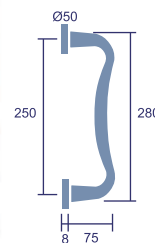

Referencia: T/Cibeles
Código: 22123
Roseta estándar
1 ud.

Glauco



E	L
200	225
250	275

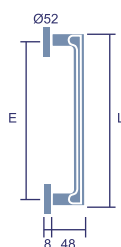

Referencia: T/Glauco-200
Código: 23575

Referencia: T/Glauco-250
Código: 23096
Roseta maciza

1 ud.

Glauco-C

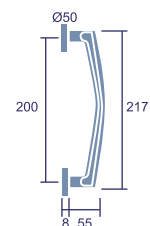

Referencia: T/Glauco-C
Código: 25644
Roseta estándar

1 ud.

Júpiter. 250mm

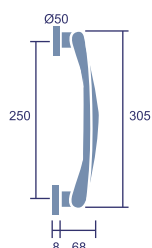

Referencia: T/Jupiter-250
Código: 23086
Roseta estándar

1 ud.

Júpiter. 200mm

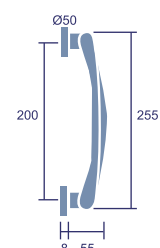

Referencia: T/Jupiter-200
Código: 25643
Roseta estándar

1 ud.

Manillas tubulares

Juno	19
Plutón	20
Tellus	21
Belona	22
Talía	22
Iris	22
Ceres	22
Baco	23
Cubo	23
Kit de placas	23

Juno



Referencia: Juno'19
 Código: 25224
 Roseta estándar
 1 jgo.

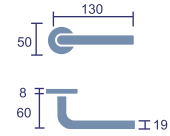

Referencia: Juno'19/MR
 Código: 26868
 Roseta 25mm
 1 jgo.

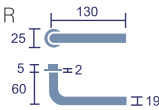

Referencia: Juno'19/RO
 Código: 26869
 Roseta ovalada
 1 jgo.

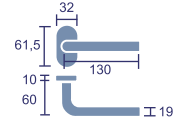

Referencia: Juno'19/O
 Código: 25225
 Placa ovalada
 1 jgo.



Referencia: Juno'19/R
 Código: 25226
 Placa rectangular
 1 jgo.



Referencia: Juno'19/V
 Código: 25229
 Manilla ventana
 1 ud.



Referencia: Juno'19/C18
 Código: 25227
 Placa cuad. 180mm
 1 jgo.

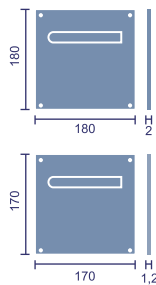

Referencia: Juno'19/C18Y
 Código: 26881
 Placa cuad. 180mm
 1 jgo.

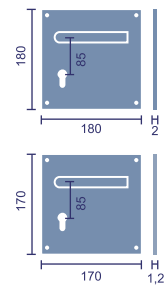

Referencia: Juno'19/C17
 Código: 25228
 Placa cuad. 170mm
 1 jgo.

Referencia: Juno'19/C17Y
 Código: 26882
 Placa cuad. 170mm
 1 jgo.

Plutón

Referencia: Pluton'19

Código: 25230

Roseta estándar

1 jgo.

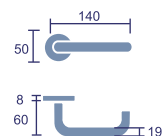

Referencia: Pluton'19/MR

Código: 26870

Roseta 25mm

1 jgo.

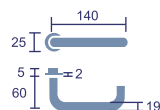

Referencia: Pluton'19/RO

Código: 26871

Roseta ovalada

1 jgo.

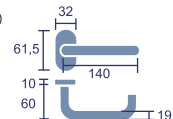

Referencia: Pluton'19/O

Código: 25231

Placa ovalada

1 jgo.



Referencia: Pluton'19/R

Código: 25232

Placa rectangular

1 jgo.



Referencia: Pluton'19/V

Código: 25235

Manilla ventana

1 ud.



Referencia: Pluton'19/C18

Código: 25233

Placa cuad. 180mm

1 jgo.

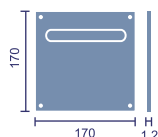
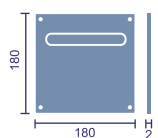

Referencia: Pluton'19/C17

Código: 25234

Placa cuad. 170mm

1 jgo.



Referencia: Pluton'19/C18Y

Código: 26883

Placa cuad. 180mm

1 jgo.

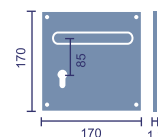
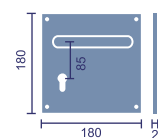

Referencia: Pluton'19/C17Y

Código: 26884

Placa cuad. 170mm

1 jgo.

Tellus

Referencia: Tellus'19

Código: 25236

Roseta estándar

1 jgo.

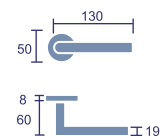

Referencia: Tellus'19/MR

Código: 26880

Roseta 25mm

1 jgo.

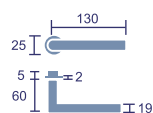

Referencia: Tellus'19/RO

Código: 26887

Roseta ovalada

1 jgo.

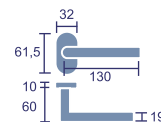

Referencia: Tellus'19/O

Código: 26888

Placa ovalada

1 jgo.



Referencia: Tellus'19/R

Código: 26889

Placa rectangular

1 jgo.



Referencia: Tellus'19/V

Código: 26894

Manilla ventana

1 ud.

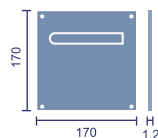
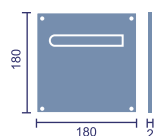

Referencia: Tellus'19/C18

Código: 26890

Placa cuad. 180mm

1 jgo.

Referencia: Tellus'19/C17

Código: 26891

Placa cuad. 170mm

1 jgo.

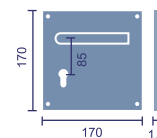
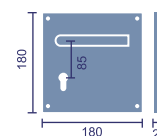

Referencia: Tellus'19/C18Y

Código: 26892

Placa cuad. 180mm

1 jgo.

Referencia: Tellus'19/C17Y

Código: 26893

Placa cuad. 170mm

1 jgo.

Belona



Referencia: Belona'19
Código: 25237
Roseta estándar

1 jgo.

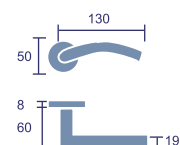

Talía



Referencia: Talía'19
Código: 25240
Roseta estándar

1 jgo.

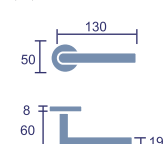

Iris



Referencia: Iris'19
Código: 25239
Roseta estándar

1 jgo.

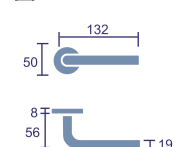

Ceres



Referencia: Ceres'19
Código: 25238
Roseta estándar

1 jgo.

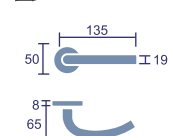

Baco



Referencia: Baco´19
 Código: 26549
 Roseta cuadrada

1 jgo.

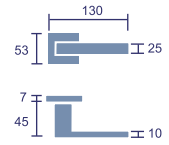

Cubo



Referencia: Cubo´19
 Código: 24345
 Roseta cuadrada

1 jgo.

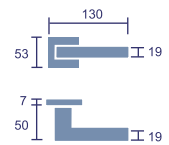

Kit de placas

Los kits de placas dan la posibilidad de montar cualquier diseño de manilla en placa rectangular u ovalada.

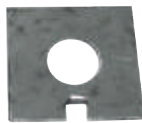

Referencia: R220
 Código: 23107
 Placa rectangular
 1 jgo.



Referencia: O226
 Código: 23106
 Placa ovalada
 1 jgo.



Cada kit incluye todas las piezas necesarias para fijar las manillas a las placas.

Tiradores tubulares

Recto con roseta	24
Set Recto (de 200 a 610mm)	25
Set recto mod. Tellus (de 200 a 500mm)	25
Set recto mod. Cubo (de 200 a 500mm)	25
Set circular (200 y 305mm)	25
Roseta para set de tiradores	25
Set curvo sin roseta (610mm)	26
Curvo con roseta (610mm)	26
Con placa rectangular	26
Con placa ovalada	26
Con placa cuadrada	26

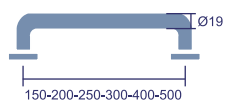

Tirador tubular recto

150 mm	Código: 23514	Referencia: TR/150R
200mm	Código: 20504	Referencia: TR/200R
250mm	Código: 20505	Referencia: TR/250R
300mm	Código: 21937	Referencia: TR/300R
400mm	Código: 21938	Referencia: TR/400R
500mm	Código: 21939	Referencia: TR/500R

 1 ud.



Tirador tubular recto. Mod. Tellus

200mm	Código: 23497	Referencia: T/TELLUS 200R
250mm	Código: 23499	Referencia: T/TELLUS 250R

 1 ud.



Set tirador tubular recto

Incluye kit de montaje con roseta embellecedora para puerta de madera y cristal.

200mm	Código: 26508	Referencia: TR/200'19
250mm	Código: 26509	Referencia: TR/250'19
300mm	Código: 26510	Referencia: TR/300'19
400mm	Código: 26511	Referencia: TR/400'19
500mm	Código: 26512	Referencia: TR/500'19
610mm	Código: 20959	Referencia: TR/610'19

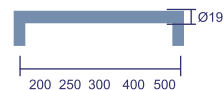

Set tirador tubular recto. Mod. Tellus

Incluye kit de montaje con roseta embellecedora para puerta de madera y cristal.

200mm	Código: 26514	Referencia: T/TELLUS/200'19
250mm	Código: 26515	Referencia: T/TELLUS/250'19
300mm	Código: 26516	Referencia: T/TELLUS/300'19
400mm	Código: 26517	Referencia: T/TELLUS/400'19
500mm	Código: 26518	Referencia: T/TELLUS/500'19

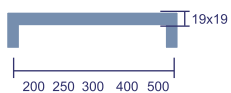

Set tirador tubular recto. Mod. Cubo

Incluye kit de montaje con roseta embellecedora para puerta de madera y cristal.

200mm	Código: 26520	Referencia: T/CUBO/200'19
250mm	Código: 26521	Referencia: T/CUBO/250'19
300mm	Código: 26522	Referencia: T/CUBO/300'19
400mm	Código: 26523	Referencia: T/CUBO/400'19
500mm	Código: 26524	Referencia: T/CUBO/500'19

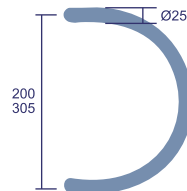

Set tirador tubular circular
Sin roseta.

200mm	Código: 20948	Referencia: TC/200
305mm	Código: 20949	Referencia: TC/305



Roseta para set de tiradores
Adaptable a kit de montaje.
Referencia: ROS-T/TUB
Código: 26537

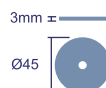

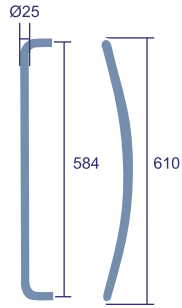

Set Tirador tubular curvo
Sin roseta.
Referencia: TC/610
Código: 20950

1 set

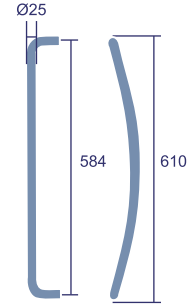

Tirador tubular curvo
Con roseta.
Referencia: TC/610R
Código: 21386

1 ud.

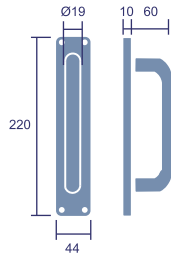

Tirador tubular recto
Placa rectangular.
Referencia: T/R220'19
Código: 26543

1 ud.

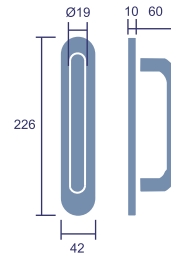

Tirador tubular recto
Placa ovalada.
Referencia: T/O226'19
Código: 26542

1 ud.

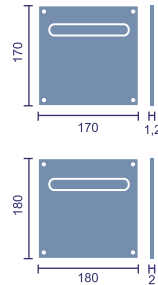

Tirador tubular recto
Placa cuadrada

Referencia: T/C170'19
Código: 26885
Placa cuad. 170mm.

2 udes.

Referencia: T/C180'19
Código: 26544
Placa cuad. 180mm.

2 udes.

Accesorios

Pomos fijos	28
Bocallaves	28
Condenas y desbloques	29
Señalización	30
Pasadores	30
Soportes pasamanos	30
Topes de puerta	31
Placa de limpieza	31
Pestillo y condena sobreponer	31
Retenedor	31
Tornillo embellecedor	31

Pomos fijos



Pomo bola puerta entrada
Referencia: PE/70-inox
Código: 25497

1 ud.

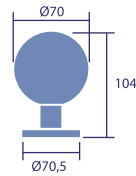

Pomo bola puerta entrada
Referencia: PE/60-inox
Código: 21384

1 ud.

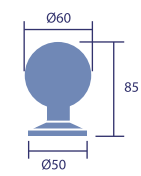

Pomo ovalado puerta entrada
Referencia: PE/70-O/inox
Código: 25641

1 ud.

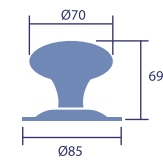

Pomo clásico puerta entrada
Referencia: PE/70-C/inox
Código: 25642

1 ud.

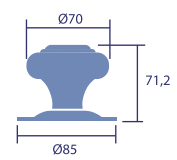

Pomo cuadrado puerta entrada
Referencia: PE/60C-inox
Código: 26555

1 ud.

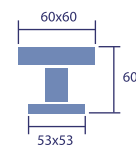

Pomo bola puerta entrada
SOBREPONER
Referencia: PE/70SOB-INOX
Código: 26936

1 ud.

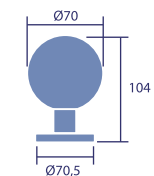

Bocallaves



Bocallave yale redondo
Referencia: IO09
Código: 21136
Roseta estándar

20 udes.



Bocallave borja redondo
Referencia: IO05
Código: 21371
Roseta estándar

20 udes.



Bocallave yale redondo
Referencia: IO13
Código: 23114
Roseta maciza

10 udes.



Bocallave borja redondo
Referencia: IO14
Código: 23115
Roseta maciza

10 udes.





Bocallave yale cuadrado
Referencia: I011-N
Código: 26366
Roseta cuadrada
20 udes.

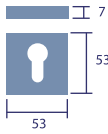

Bocallave borja cuadrado
Referencia: I012-N
Código: 26901
Roseta cuadrada
20 udes.

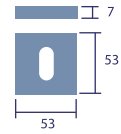

Bocallave ovalado
Referencia: I025
Código: 26872
30 udes.

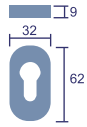

Bocallave escudo ciego
Referencia: I022
Código: 26873
30 udes.

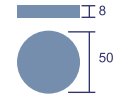

Bocallave yale minirroseta
Referencia: I027
Código: 26897
50 udes.

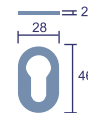

Condenas y desbloques



Condena con desbloqueo 50mm
Referencia: I2285AI-L
Código: 20511
Roseta estándar
1 jgo.



Condena con desbloqueo 53mm
Referencia: I2295
Código: 23111
Roseta cuadrada
1 jgo.

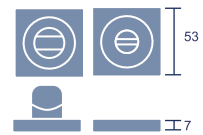

Condena con desbloqueo 50mm L/O
Referencia: I2285L-O
Código: 20512
Roseta estándar
1 jgo.



Condena con desbloqueo 52mm
Referencia: I2280
Código: 23112
Roseta maciza
1 jgo.



Condena con desbloqueo 35mm
Referencia: I2270AI
Código: 23388
Roseta estándar
1 jgo.

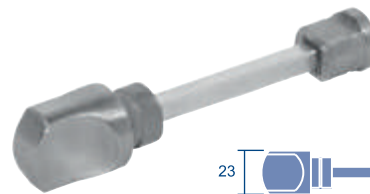

Muletilla con desbloqueo
Referencia: I2281AI
Código: 21385
Roseta estándar
10 udes.



Condena con desbloqueo 50mm Discap.
Referencia: I2285DIS
Código: 20956
Roseta estándar
1 jgo.

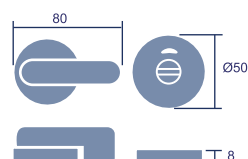



Condensa con desbloqueo 25mm
Referencia: I2285MR
Código: 26896

10 udes.

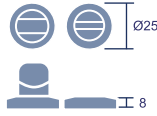

Bocallave yale tirador
Referencia: IO10
Código: 22128

10 udes.

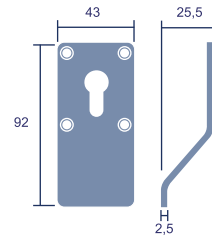

Señalización

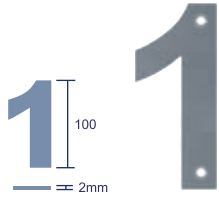

Código: 25956 Referencia: **N0**/100inox
Código: 25957 Referencia: **N1**/100inox
Código: 25958 Referencia: **N2**/100inox
Código: 25959 Referencia: **N3**/100inox
Código: 25960 Referencia: **N4**/100inox
Código: 25961 Referencia: **N5**/100inox
Código: 25962 Referencia: **N6**/100inox
Código: 25963 Referencia: **N7**/100inox
Código: 25964 Referencia: **N8**/100inox
Código: 25965 Referencia: **N9**/100inox

5 udes.

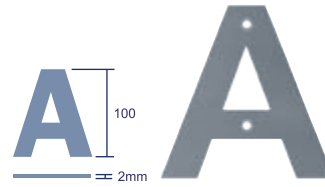

Código: 25966 Referencia: **LA**/100inox
Código: 25967 Referencia: **LB**/100inox
Código: 25968 Referencia: **LC**/100inox
Código: 25969 Referencia: **LD**/100inox
Código: 25970 Referencia: **LE**/100inox
Código: 25971 Referencia: **LF**/100inox

5 udes.



Hombres Código: 20951 Referencia: IO01
Mujeres Código: 20952 Referencia: IO02
Mujer/hombre Código: 25872 Referencia: IO15
Discapacitados Código: 20953 Referencia: IO03
Toilette Código: 21561 Referencia: IO04
Prohibido fumar Código: 25873 Referencia: IO16
Babe change Código: 26874 Referencia: IO21

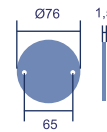

10 udes.

Pasadores



Pasador de embutir macizo 200mm
Referencia: PEM/200
Código: 26840

Pasador de embutir macizo 300mm
Referencia: PEM/300
Código: 26841

2 udes.

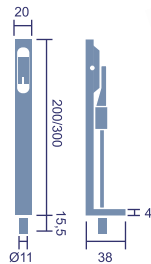

Pasador de embutir 150mm
Referencia: PE/150
Código: 26842

Pasador de embutir 200mm
Referencia: PE/200
Código: 20228

Pasador de embutir 300mm
Referencia: PE/300
Código: 20958

2 udes.



Soportes pasamanos



Sop. Pasamanos esparrago
Referencia: SP02/inox
Código: 26556

1 ud.

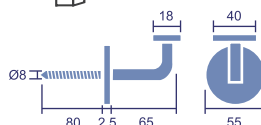

Sop. Pasamanos sobreponer
Referencia: SP01/inox
Código: 25257

1 ud.

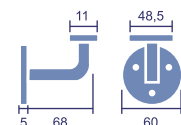

Topes de puerta



Tope puerta Ø19mm
Referencia: TP104
Código: 25499
20 udes.

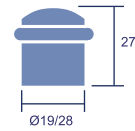

Tope puerta Ø28mm
Referencia: TP103
Código: 25498
5 udes.



Tope puerta Ø24mm
Referencia: TP102/304
Código: 26886
8 udes.

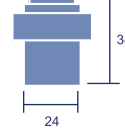

Tope puerta Ø44mm
Referencia: TP107
Código: 24999
10 udes.

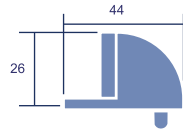

Placa de limpieza



Placa de limpieza 170mm
Referencia: PL/170
Código: 26895

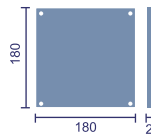

Placa de limpieza 180mm
Referencia: PL/180
Código: 21383

10 udes.

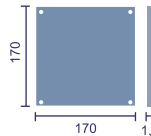

Pestillo y condena sobreponer



Pestillo sobreponer
Referencia: I026
Código: 26877
10 udes.

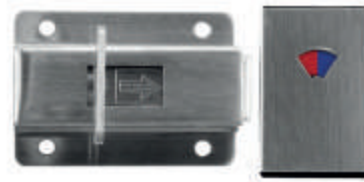
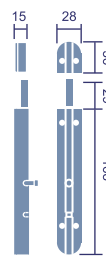

Condena sobreponer
Referencia: I2297
Código: 26847
1 ud.

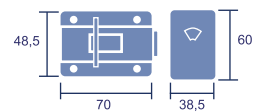

Retenedor



Retenedor
Referencia: I023
Código: 26875
6 udes.

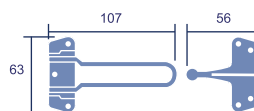

Tornillo embellecedor



Tornillo embellecedor
Referencia: I024
Código: 26876
200 udes.

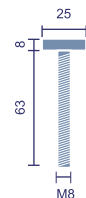

Accesorios baño

Modelo Lara	32
Modelo Diana	34

Lara

Toallero 1 barra 450mm
Referencia: LARA/004-45
Código: 23430

 1 ud.

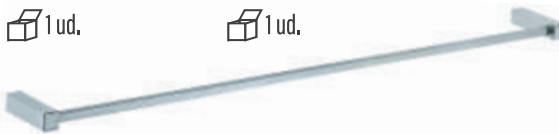

Toallero 1 barra 600mm
Referencia: LARA/004-60
Código: 25877

 1 ud.



Toallero 2 barras 450mm
Referencia: LARA/005-45
Código: 23431

 1 ud.



Toallero 2 barras 600mm
Referencia: LARA/005-60
Código: 25878

 1 ud.



Toallero 2 barras giratorio 600mm
Referencia: LARA/006
Código: 25879

 1 ud.



Toallero anilla
Referencia: LARA/009
Código: 25882

 1 ud.

Repisa toallas 600mm
Referencia: LARA/007
Código: 25880

 1 ud.



Repisa toallas con barra toallero
Referencia: LARA/008
Código: 25881

 1 ud.



Repisa cristal 600mm
Referencia: LARA/001
Código: 25874

1 ud.



Jabonera ducha esquina
Referencia: LARA/018
Código: 25893

1 ud.



Jabonera ducha
Referencia: LARA/017
Código: 25892

1 ud.



Jabonera ducha doble altura
Referencia: LARA/019
Código: 25894

1 ud.



Percha 3 ganchos
Referencia: LARA/016
Código: 25891

1 ud.



Percha 1 gancho
Referencia: LARA/014
Código: 25889

1 ud.



Dosificador jabón sobremesa
Referencia: LARA/010S
Código: 25884

1 ud.



Percha 2 ganchos
Referencia: LARA/015
Código: 25890

1 ud.



Portarrollo repuesto
Referencia: LARA/012
Código: 25886

1 ud.



Dosificador jabón pared
Referencia: LARA/010P
Código: 25883

1 ud.



Sop. pared vaso inox
Referencia: LARA/002
Código: 25875

1 ud.



Portarrollo
Referencia: LARA/011
Código: 25885

1 ud.



Sop. pared vaso cristal
Referencia: LARA/003
Código: 25876

1 ud.



Escobillero pared
Referencia: LARA/013P
Código: 25887

1 ud.



Escobillero suelo
Referencia: LARA/013S
Código: 25888

1 ud.

Diana

Toallero 1 barra 450mm
Referencia: DIANA/004-45
Código: 23432

 1 ud.



Toallero 1 barra 600mm
Referencia: DIANA/004-60
Código: 25898

 1 ud.



Toallero 2 barras 450mm
Referencia: DIANA/005-45
Código: 23433

 1 ud.



Toallero 2 barras 600mm
Referencia: DIANA/005-60
Código: 25899

 1 ud.



Toallero 2 barras giratorio 600mm
Referencia: DIANA/006
Código: 25900

 1 ud.



Toallero anilla
Referencia: DIANA/009
Código: 25903

 1 ud.

Repisa toallas 600mm
Referencia: DIANA/007
Código: 25901

 1 ud.



Repisa toallas con barra toallero
Referencia: DIANA/008
Código: 25902

 1 ud.



Repisa cristal 600mm
Referencia: DIANA/001
Código: 25895

 1 ud.



Jabonera ducha esquina
Referencia: DIANA/018
Código: 25914

 1 ud.

Jabonera ducha
Referencia: DIANA/017
Código: 25913

 1 ud.



Jabonera ducha doble altura
Referencia: DIANA/019
Código: 25983

 1 ud.



Percha 3 ganchos
Referencia: DIANA/016
Código: 25912

 1 ud.



Percha 1 gancho
Referencia: DIANA/014
Código: 25910

 1 ud.



Percha 2 ganchos
Referencia: DIANA/015
Código: 25911

 1 ud.



Dosificador jabón pared
Referencia: DIANA/010P
Código: 25904

 1 ud.



Sop. pared vaso cristal
Referencia: DIANA/003
Código: 25897

 1 ud.



Sop. pared vaso inox
Referencia: DIANA/002
Código: 25896

 1 ud.



Portarollo
Referencia: DIANA/011
Código: 25906

 1 ud.



Escobillero pared
Referencia: DIANA/013P
Código: 25908

 1 ud.

Cabinas sanitarias

Soporte lateral	37
Soporte superior	37
Conector de tubo	38
Ángulo de unión	38
Condena	38
Bisagras	38
Soporte a suelo	39
Percha	39
Pomos	39
Barra tubular y perfiles	39

Barras de apoyo baño

Barra recta 300 y 600mm	40
Barra 135°	40
Barra abatible	40

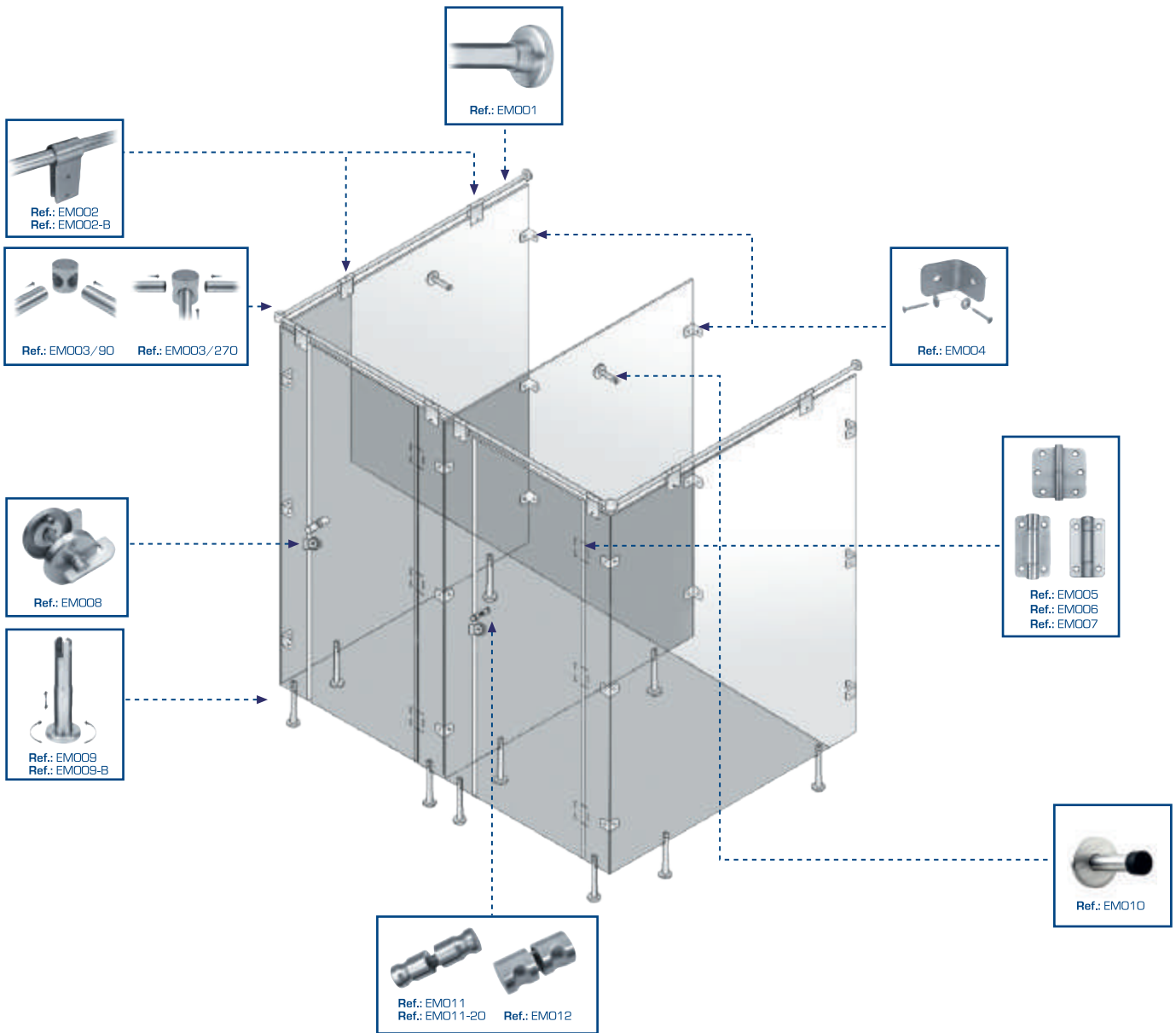

Soporte lateral
Referencia: EM001
Código: 23216
5 udes.

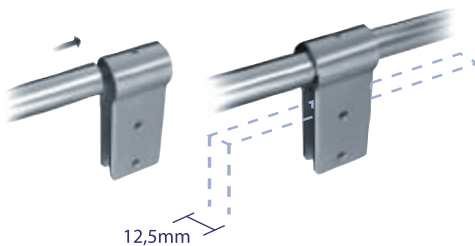
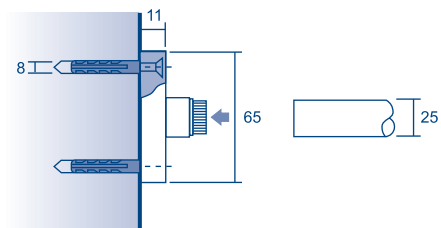

Soporte superior 50mm
Referencia: EM002
Código: 23217

Soporte superior 40mm
Referencia: EM002-B
Código: 26503
7 udes.

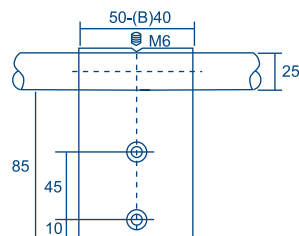

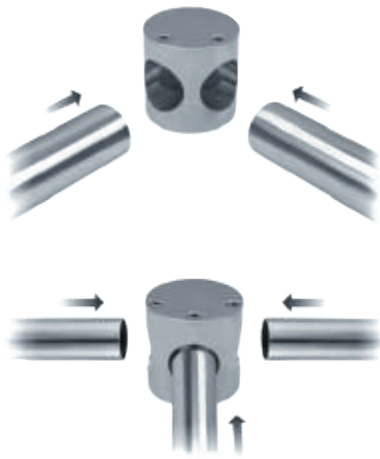

Conector tubo 90°
Referencia: EM003/90
Código: 23218

Conector tubo 270°
Referencia: EM003/270
Código: 23219

9 udes.

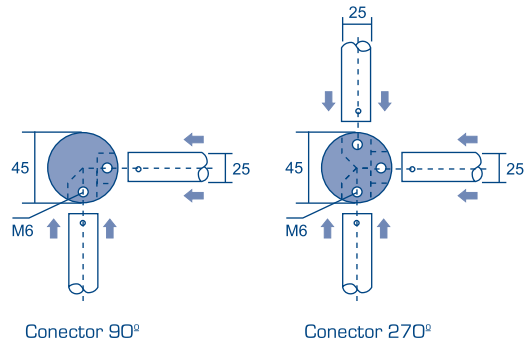

Conector 90°

Conector 270°

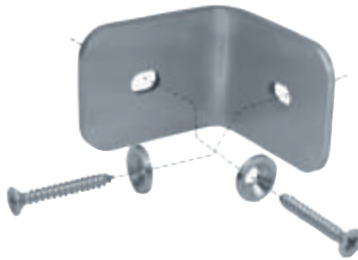

Ángulo unión
Referencia: EM004
Código: 23220

20 udes.

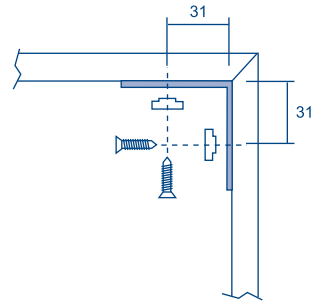

Condensa
Referencia: EM008
Código: 23224

5 udes.

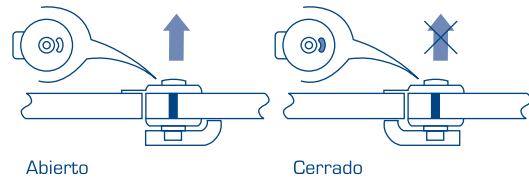

Abierto

Cerrado



Bisagra desmontable, Derecha
Referencia: EM005/D
Código: 23221

Bisagra desmontable, Izquierda
Referencia: EM005/I
Código: 25270

20 udes.

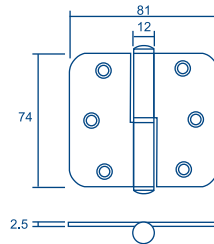

Bisagra fija
Referencia: EM006
Código: 23222

20 udes.

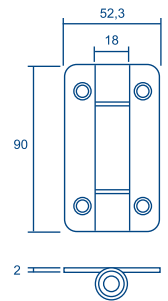

Bisagra fija con muelle
Referencia: EM007
Código: 23223

20 udes.

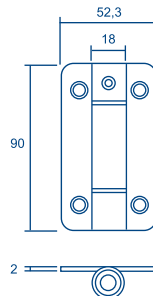



SopORTE ajustable núcleo inox
Referencia: EM009
Código: 23225

SopORTE ajustable núcleo cincado
Referencia: EM009-B
Código: 26504

4 udes.

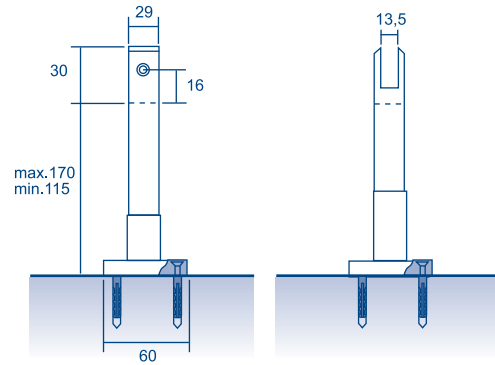

Percha
Referencia: EM010
Código: 23226

10 udes.

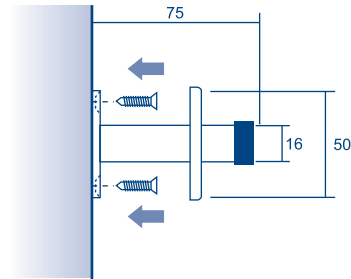

Pomo fijo 20mm
Referencia: EM011-20
Código: 26505

Pomo fijo 25mm
Referencia: EM011
Código: 23227

10 udes.

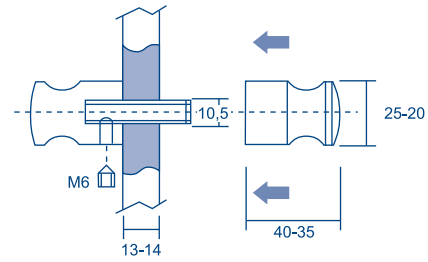

Pomo fijo 52mm
Referencia: EM012
Código: 23228

1 ud.

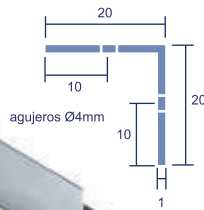
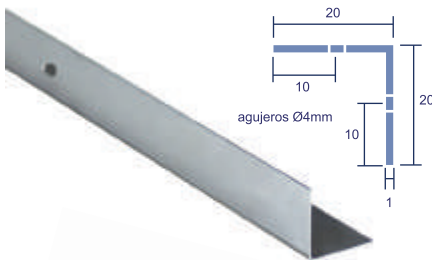
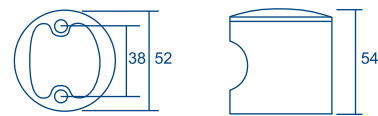

Perfil "L" pul. exterior 1,8m.
Referencia: EM014
Código: 26844

Perfil "L" pul. interior 1,8m.
Referencia: EM013
Código: 26843

6 udes.

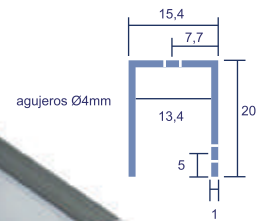

Perfil "U" 1,8m.
Referencia: EM015
Código: 26845

6 udes.



Barra tubular 3m.
Referencia: EM016
Código: 26846

5 udes.

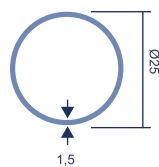

Barras de apoyo



Barra apoyo recta 300mm
Referencia: BA001
Código: 23229

1 ud.

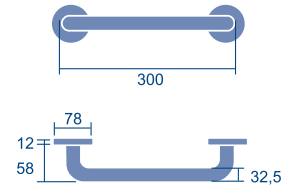
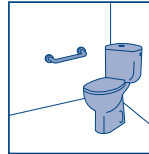

Barra apoyo recta 600mm
Referencia: BA002
Código: 23230

1 ud.

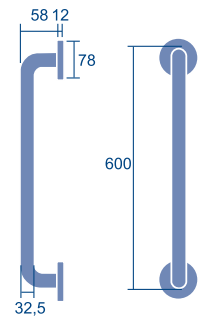
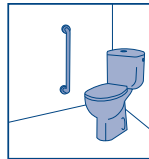

Barra apoyo 135°
Referencia: BA003
Código: 23231

1 ud.

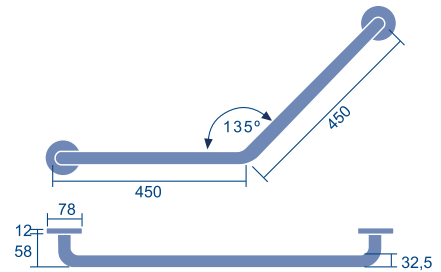
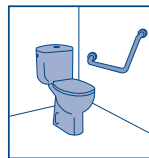

Barra apoyo abatible
Referencia: BA004
Código: 23232

1 ud.

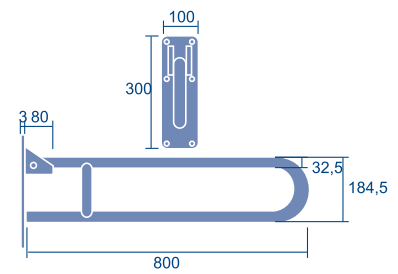
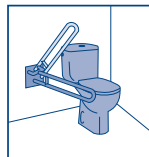

Bisagras y pernios

Pernio pala ancha	42
Pernio pala estrecha	42
Bisagra quita y pon	42
Bisagra oculta	42
Bisagra simple acción	42
Bisagra doble acción	42
Bisagra antipalanca	43



Pernio pala ancha
canto cuadrado

Referencia: N1086
Código: 21106. DCHA
Código: 21107. IZDA

Referencia: N1286
Código: 21108. DCHA
Código: 21109. IZDA

10 udes.

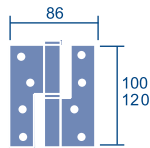

Pernio pala ancha
canto redondo

Referencia: N1086CR
Código: 21110. DCHA
Código: 21111. IZDA

Referencia: N1286CR
Código: 21112. DCHA
Código: 21113. IZDA

10 udes.

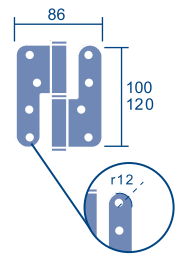

Pernio pala estrecha
canto redondo

Referencia: N305inox/100
Código: 23000. DCHA
Código: 23001. IZDA

20 udes.

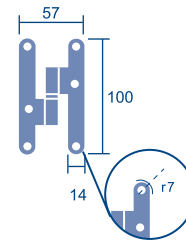

Bisagra quita y pon
canto cuadrado

Referencia: N9065
Código: 20376. DCHA
Código: 20377. IZDA

Referencia: N1065
Código: 23315. DCHA
Código: 23316. IZDA

10 udes.

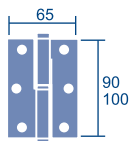

Bisagra quita y pon
canto redondo

Referencia: N9065CR
Código: 20283. DCHA
Código: 20284. IZDA

Referencia: N1065CR
Código: 23317. DCHA
Código: 23318. IZDA

10 udes.

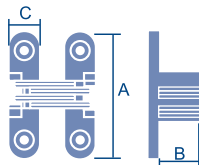
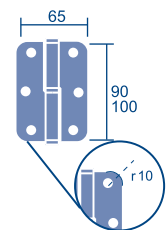

Bisagra oculta. Canto redondo

Código: 22889 Referencia: N820
Código: 22890 Referencia: N821
Código: 22891 Referencia: N829
Código: 22892 Referencia: N830
Código: 22893 Referencia: N831
Código: 22894 Referencia: N832

Medidas AxBxC	Ancho puerta	Kg. soportados	10 udes.
45x18x13	20-30mm	5	2 udes.
60x18x13	20-30mm	10	2 udes.
70x18x16	25-35mm	15	2 udes.
95x27x19	30-40mm	25	2 udes.
117x37x25	35-50mm	40	2 udes.
140x50x35	50-70mm	60	2 udes.

*Se recomienda usar 3 bisagras por puerta, teniendo en cuenta su ancho y su peso.

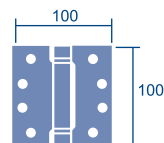

Bisagra simple acción 100mm
Referencia: N1040
Código: 21104

2 udes.

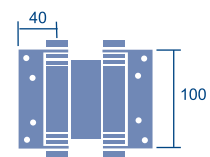

Bisagra doble acción 100mm
Referencia: N222/100inox
Código: 23239

2 udes.

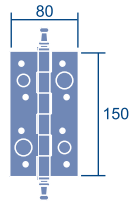

Bisagra antipalanca con remate
canto cuadrado
Referencia: N115AI
Código: 23099

24 udes.

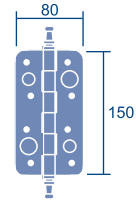

Bisagra antipalanca con remate
canto redondo

Radio 12
Referencia: N107AI/R12
Código: 23104

Radio 16
Referencia: N107AI/R16
Código: 23103

24 udes.

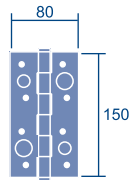

Bisagra antipalanca sin remate
canto cuadrado
Referencia: N100AI
Código: 23100

10 udes.

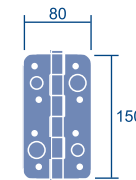

Bisagra antipalanca sin remate
canto redondo

Radio 12
Referencia: N105AI/R12
Código: 23102

Radio 16
Referencia: N105AI/R16
Código: 23101

10 udes.

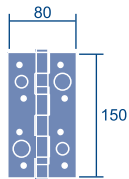

Bisagra antipalanca sin remate
canto cuadrado con rodaminetos
Referencia: N100AI-R
Código: 25921

10 udes.

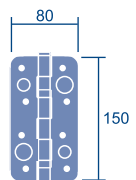

Bisagra antipalanca sin remate
canto redondo con rodamientos

Radio 12
Referencia: N105AI/R12-R
Código: 25923

Radio 16
Referencia: N105AI/R16-R
Código: 25922

10 udes.

Picaportes y cerraduras

Picaporte unificado	44
Cerradura de entrada	45
Cerradura de seguridad	45

Picaporte unificado

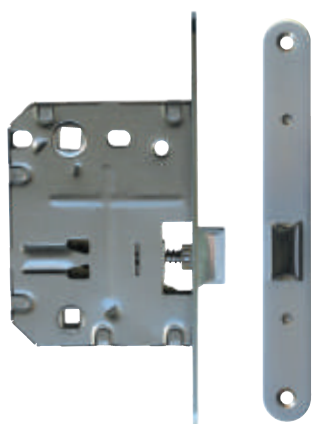

70mm
Referencia: N134T
Código: 23713

70mm resbalón silencioso
Referencia: N134T-SIL
Código: 23707

10 udes.

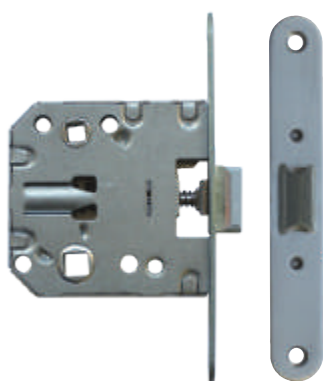
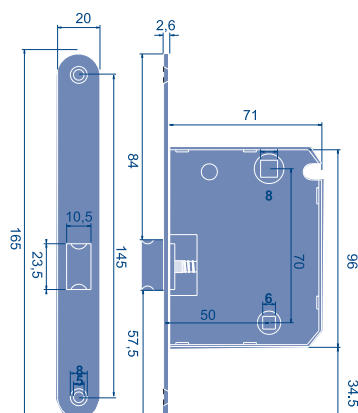

47mm
Referencia: N6134T
Código: 23710

47mm resbalón silencioso
Referencia: N6134T
Código: 23704

10 udes.

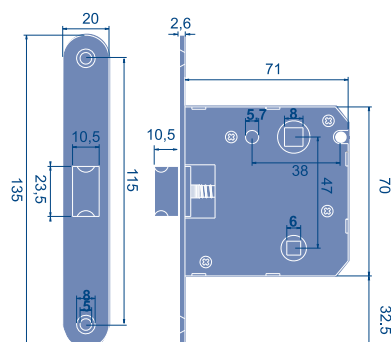

Cerradura de entrada

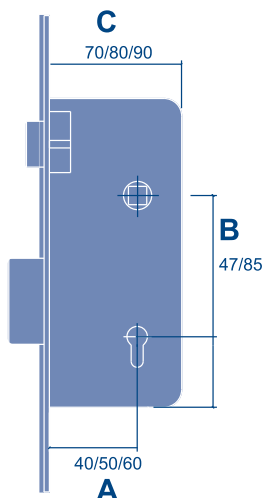
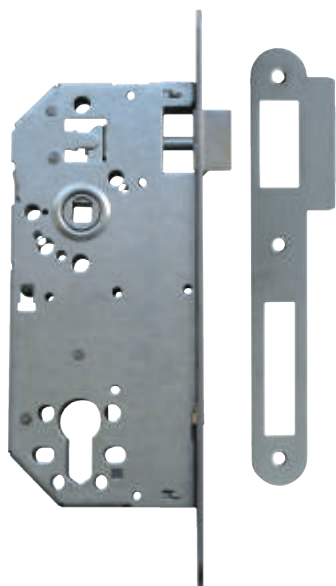

A: Distancia de entrada,
(Del frente al eje del cuadrado).
B: Distancia entre ejes.
C: Ancho de caja.

Cerradura de entrada E.E. 85mm

Código	Referencia	AxBxC	Canto
Código: 26134	Referencia: N30/40CC	40x85x70	cuadrado
Código: 26137	Referencia: N30/40CR	40x85x70	redondo
Código: 26140	Referencia: N30/50CC	50x85x80	cuadrado
Código: 26143	Referencia: N30/50CR	50x85x80	redondo
Código: 26146	Referencia: N30/60CC	60x85x90	cuadrado
Código: 26149	Referencia: N30/60CR	60x85x90	redondo

1 ud.



Cerradura de entrada E.E. 47mm

Código	Referencia	AxBxC	Canto
Código: 26116	Referencia: N10P/40CC	40x47x70	cuadrado
Código: 26119	Referencia: N10P/40CR	40x47x70	redondo
Código: 26122	Referencia: N10P/50CC	50x47x80	cuadrado
Código: 26125	Referencia: N10P/50CR	50x47x80	redondo
Código: 26128	Referencia: N10P/60CC	60x47x90	cuadrado
Código: 26131	Referencia: N10P/60CR	60x47x90	redondo

1 ud.

Cerradura de seguridad

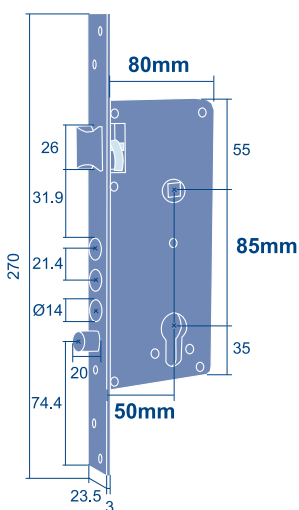

Escudo abierto

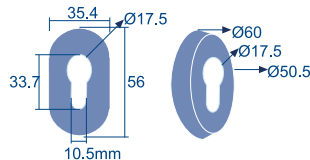

Cerradura seguridad E.E. 85mm

Código	Referencia	Medidas	Canto
Código: 26112	Referencia: NX100CCAI	50x85x80	cuadrado
Código: 26113	Referencia: NX100CRAI	50x85x80	redondo

Escudo cerrado

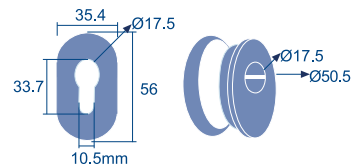

Cerradura seguridad E.E. 85mm

Código	Referencia	Medidas	Canto
Código: 26108	Referencia: NX200CCAI	50x85x80	cuadrado
Código: 26109	Referencia: NX200CRAI	50x85x80	redondo

Tiradores para mueble

Tiradores embutir	46
Tirador armario y maletero	47
Asas para mueble	47
Pomos para mueble	48

Tiradores embutir

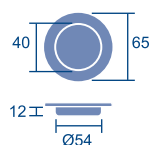

Tirador embutir circular
Referencia: I008
Código: 20954

10 udes.

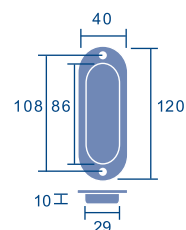

Tirador embutir ovalado
Referencia: I007
Código: 20955

10 udes.

Tirador embutir rectangular
Referencia: I020

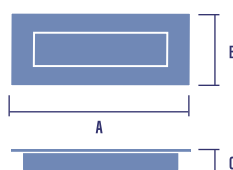

	A	B	C	
Código: 26552	100	50	12	10 udes.
Código: 26596	120	40	13	20 udes.
Código: 26566	150	50	14,5	10 udes.
Código: 26553	300	37	12	7 udes.

Tirador armario y maletero

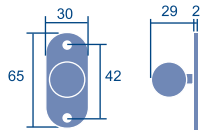

Tirador maletero
Referencia: I018
Código: 25946
20 udes.

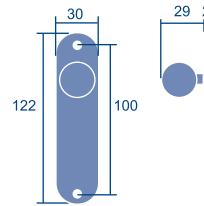

Tirador armario
Referencia: I017
Código: 25945
20 udes.

Asas mueble



Asa mueble
Referencia: AMI 01/304
Código: 24432
20 udes.

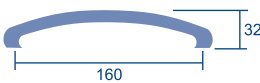

Asa mueble
Referencia: AMI 02/304
Código: 24433
20 udes.

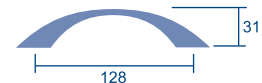

Asa mueble Ø12mm
Referencia: AMI 12/202

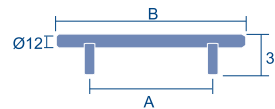

Cód.	A	B	u	Cód.	A	B	u	Cód.	A	B	u	Cód.	A	B	u
23098	96	160	50	22811	288	352	30	25740	512	576	10	25746	736	800	10
22808	128	192	50	25737	320	384	10	25741	544	608	10	25747	768	832	10
22809	160	224	50	22921	352	392	10	25742	576	640	10	25748	832	896	10
21655	192	256	50	22812	384	448	20	25743	608	672	10	25749	896	960	10
22810	224	288	40	25738	416	480	20	25744	640	704	10	25750	960	1024	10
23113	256	320	25	22813	448	512	20	22814	672	736	10	22815	1184	1248	10
				25739	480	544	20	25745	704	768	10	25751	1376	1440	10



Asa mueble cuadrada 12mm
Referencia: AMI 12C/202



Cód.	A	u
25786	96	25
25787	128	25
25788	160	25
25789	192	25
25790	224	25
25791	256	25
25792	288	25
25793	320	25
24521	512	25
24522	608	25
24523	704	25

Pomos mueble



	A	B	
Cód.: 24434	20	25,5	20
Cód.: 24435	25	31	20

Referencia: PMI 01/304

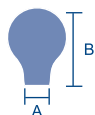

	A	B	
Cód.: 24453	10	20	50
Cód.: 24436	15	26	50
Cód.: 24437	20	28	20
Cód.: 24452	25	30	20

Referencia: PMI 02/304



	A	B	
Cód.: 24438	11	25,5	50
Cód.: 24439	20	30	20

Referencia: PMI 03/304

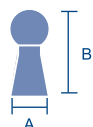

	A	B	
Cód.: 24440	15	24	50
Cód.: 24441	20	26	20

Referencia: PMI 04/304



Referencia: PMI 05/304
Código: 24442

20 udes.

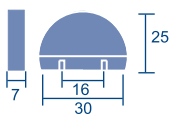

	A	B	
Cód.: 24443	15	22	50
Cód.: 24163	20	30	20

Referencia: PMI 06/304

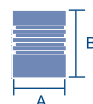

	A	B	C	
Cód.: 24444	20	17	13	20
Cód.: 24445	30	25	20	20
Cód.: 24446	40	34	26	20

Referencia: PMI 07/304

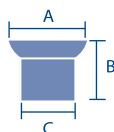

	A	B	
Cód.: 24447	20	21,5	20
Cód.: 24448	25	25	20

Referencia: PMI 08/304

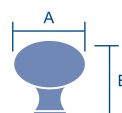

	A	B	C	
Cód.: 24449	20	26	10	20
Cód.: 24450	25	30	12	20
Cód.: 24451	30	37	14	20

Referencia: PMI 09/304



	A	B	
Cód.: 26562	20	31	10
Cód.: 26561	25	38	10

Referencia: PMI 10/304

